

2" PLASTIC FLAP VALVE PUMP

AIR OPERATED DOUBLE DIAPHRAGM (AODD) PUMP

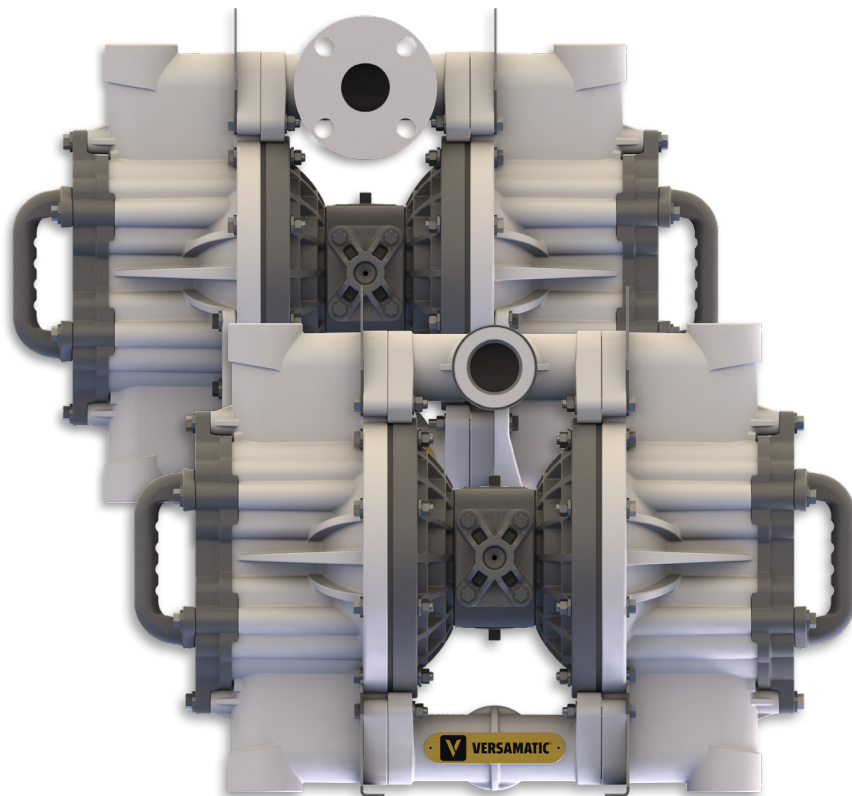

The 2" (50.8 mm) plastic Flap Valve Pump was designed to offer superior solids handling in a chemically resistant light weight portable design. These attributes make it perfect for chemical sump, utility and mine de-watering applications.

SOLIDS HANDLING RANGE

Up to 1.8" (46mm)

LIGHTWEIGHT & PORTABLE

At 53 lbs (24 kg) it is safely and easily transported

TOP SUCTION / BOTTOM DISCHARGE

Gravity assist is ideal for pumping liquids with settling solids

BEST-IN-CLASS AIR EFFICIENCY

Less than 65 SCFM at Max pump flow

ALL BOLTED CONSTRUCTION

Rugged, leak free design

SUPERIOR DRY PRIME

Up to 19' (5.8 m) of water



VERSAMATIC[®]
PUMPING MADE EASY

REDEFINING THE FLAP VALVE PUMP

YOUR CHEMICAL SUMP, GENERAL UTILITY, AND MINE DE-WATERING SOLUTION

The robust, yet lightweight design allows for ease of maintenance and movement, and is ideal for handling solids and corrosive fluids. This unique pump has been engineered to fully function in any position, includes lifting handles and hanging points, and has durable mounting feet. This is an ideal solution for numerous applications.

LIGHTWEIGHT & DURABLE

The non-metallic, lightweight design makes it easily portable at 53 lbs (24 kg)

RELIABILITY GUARANTEE

Strongest diaphragm connecting rod in the industry is guaranteed to not bend or yield in operation

RUGGED DESIGN

Stainless steel seats prevent abrasion when pumping solids laden fluids

OPTIMUM SOLIDS HANDLING

Hinge pads exert positive pressure on the flaps, allowing the pump to operate in virtually any position; they help deliver superior suction lift and flow rates

LONG LIFE

A proven diaphragm design in conjunction with exclusive wear pads reduce plate abrasion, delivering extended life

PURPOSE BUILT BASE

The threaded version features stainless steel mounting feet and the flanged version features Polypropylene mounting feet

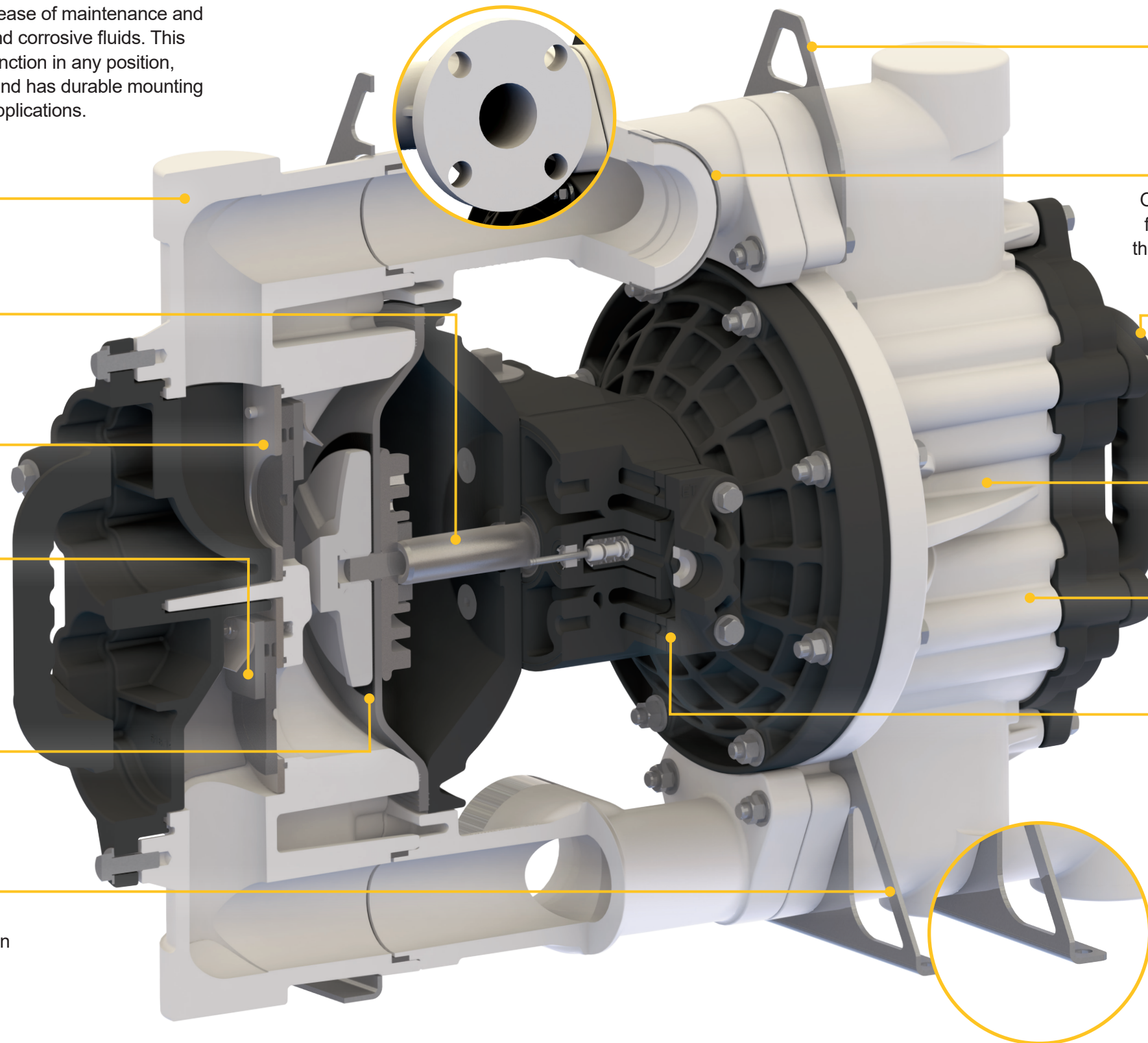

INDUSTRIAL MOUNTING CAPABILITIES

Addition of stainless steel hanging points located on the manifold allow for multiple mounting options and lifting

STRONG MANIFOLD CONNECTIONS

Optional flanged or threaded connection for additional flexibility: Stainless steel reinforcing rings help protect the threaded manifold connections from being damaged

ERGONOMIC HANDLE

Lifting handles come standard, allowing for easy pump transport; handles can be rotated 90 degrees for proper ergonomics, depending on desired use

UNSURPASSED PERFORMANCE

Industry leading flow rates, suction lift, air efficiency and displacement per stroke

VERSATILE DESIGN

This pump will function in any position, including uneven surfaces

SIMPLE MAINTENANCE

Our Air Distribution System and externally serviceable flap valve modules make in-field service quick and easy, saving you from unnecessary downtime

PERFORMANCE & DIMENSIONS

MAX CAPACITY
150 GPM (568 LPM)

DISPLACEMENT PER STROKE
.50 Gal (1.9 L)

MAX DISCHARGE PRESSURE
100 PSI (7.0 BAR)

PIPE SIZE
2" NPT / BSP / ANSI / DIN Flange

MAX SOLIDS HANDLING
1.8" (46mm)

AIR END/WET END
Polypropylene / Stainless Steel
Seats (Wet End Only)

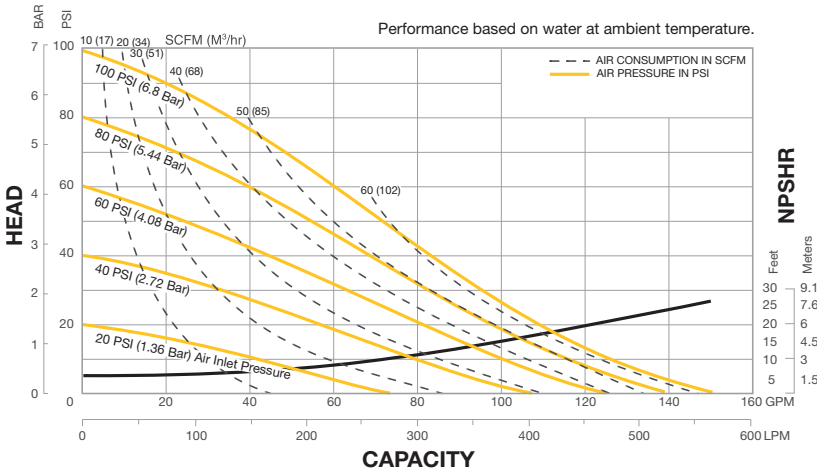

2" PLASTIC FLAP VALVE PUMP WITH THREADED PORTING

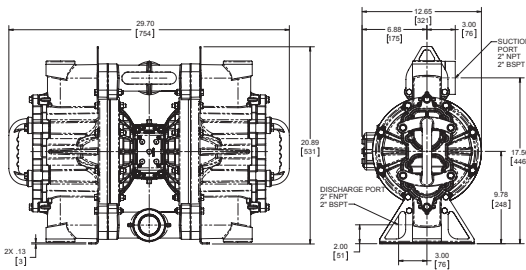

2" PLASTIC FLAP VALVE PUMP WITH FLANGED PORTING

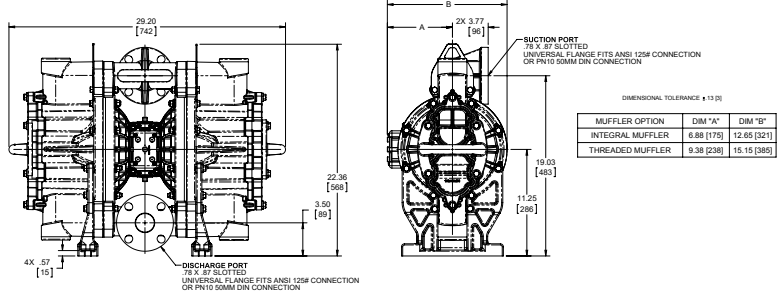

EASE OF MAINTENANCE

Quick Access to Serviceable Components

REMOVE CLEAN-OUT CAP

By simply removing six bolts securing the clean-out cap in place, it allows access to clear simple clogs without disassembling the entire pump

MODULAR CHECK VALVE ACCESS

With the clean-out cap removed, the flap valves can be inspected and / or replaced as needed; four bolts hold the modular flap valves in place for quick maintenance and repair

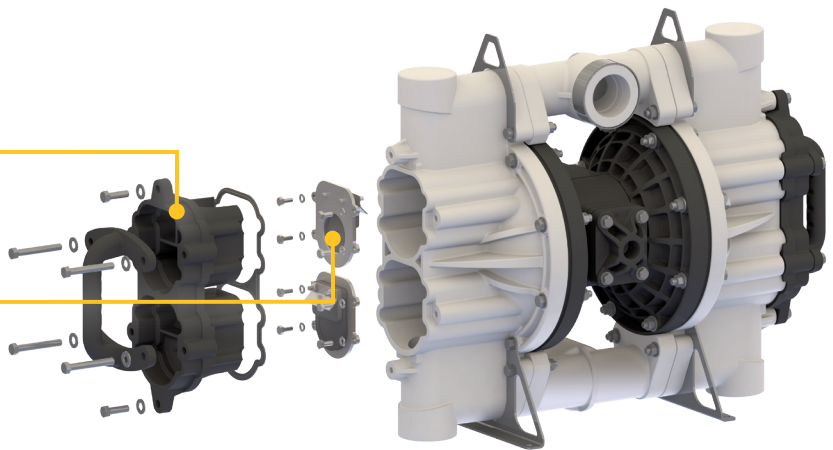

Warren Rupp, Inc. | A Unit of IDEX Corporation
800 North Main Street | Mansfield, OH 44902 USA
Phone: 419.526.7296 | Fax: 419.526.7289



VM_BRO_2" Plastic FV Pump-0719

©Copyright 2019 Warren Rupp, Inc. All Rights Reserved.